

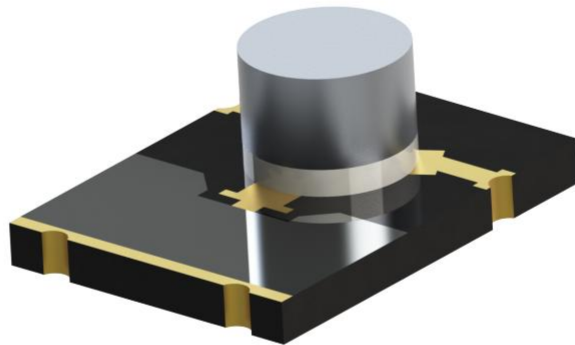

OG5A016-15-18



Features

- Miniaturized and lightweight
- High product consistency and high reliability
- Customizable
- Suitable for aviation, aerospace, radar, electronic countermeasure, microwave communication, and microwave testing fields

Description

The product named OG5A016 is high-performance microstrip surface-mount isolator that plays a role in impedance matching and decoupling in integrated circuits, while providing unidirectional transmission and signal processing functions. Its production process is straightforward and well-suited for microwave hybrid integrated circuits.



Technical indicators

Model Number	Freq. (MHz)	Bandwidth	Insertion Loss (dB)	Isolation (dB)	Return Loss (dB)	Power (W)	Reflected Power (W)	a	b	c	d	e	Operating Temp (°C)
OG5A016	15-18	full	0.7	18.0	1.30	12.0	3.0	4.0	6.0	3.0	0.5	0.8	-55~+85

Mechanical Outline

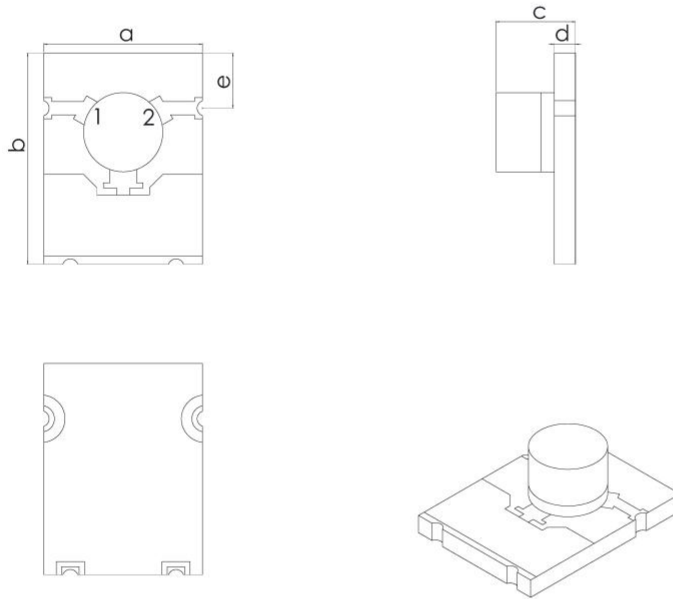



Performance Data

