



# OH103C-3800-4200



## Features

- Stripline design
- Surface mount package
- Operating frequency from 1805 to 5000 MHz
- High power handling up to 100W
- Excellent isolation and return loss
- Wide operating temperature range

## Description

The product named OH103C is high-performance stripline surface mount circulator designed for high-power communication systems, offering low insertion loss and high isolation across multiple frequency bands.



### Technical Indicators

Size Spec	Part Number	Freq. (MHz)	Return Loss (dB)	Isolation (dB)	Insertion Loss (dB)	IMD3 (dBc)	Power (W)	Operating Temp (°C)
12.5mm	OH103C	3800-4200	20	20	0.30	-60 (2*10W)	100	-40 ~ 105

### Mechanical Outline

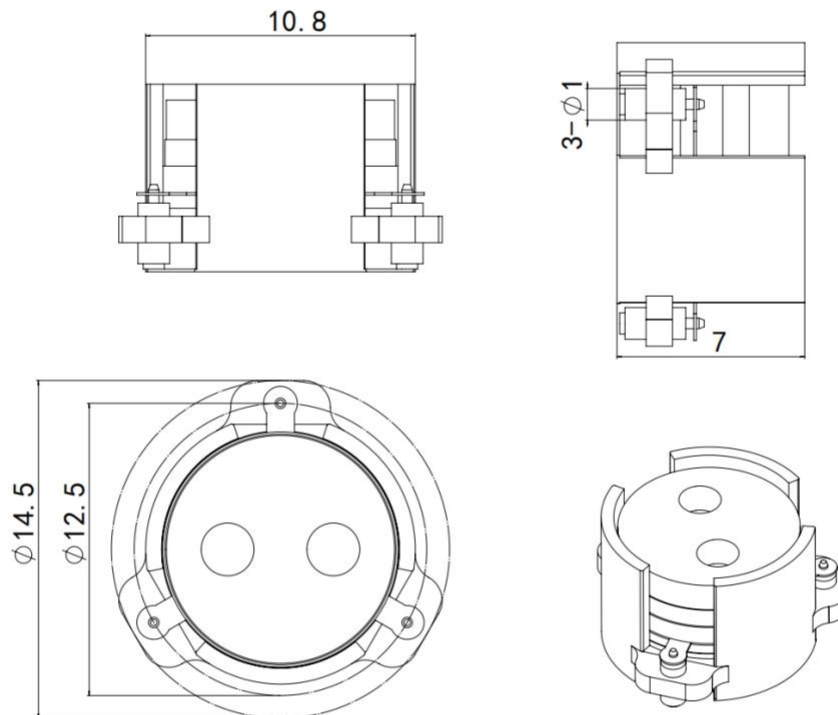



## Performance Data

