



OH103C-4400-5000



Features

- Stripline design
- Surface mount package
- Operating frequency from 1805 to 5000 MHz
- High power handling up to 100W
- Excellent isolation and return loss
- Wide operating temperature range

Description

The product named OH103C is high-performance stripline surface mount circulator designed for high-power communication systems, offering low insertion loss and high isolation across multiple frequency bands.



Technical Indicators

Size Spec	Part Number	Freq. (MHz)	Return Loss (dB)	Isolation (dB)	Insertion Loss (dB)	IMD3 (dBc)	Power (W)	Operating Temp (°C)
12.5mm	OH103C	4400-5000	19	19	0.35	-60 (2*10W)	100	-40 ~ 105

Mechanical Outline

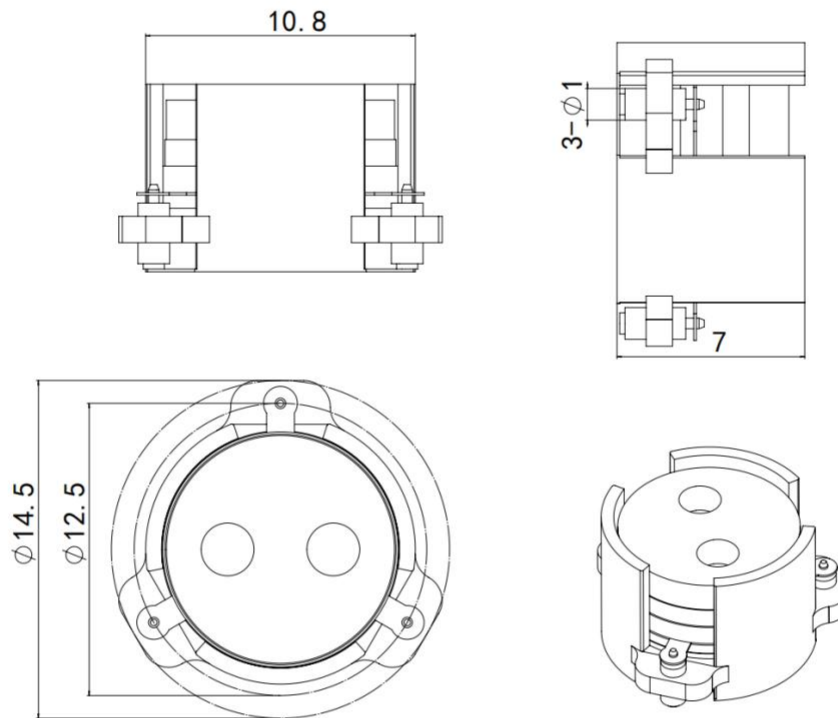



Performance Data

