



OH103E-2496-2690



Features

- Surface Mount Package
- Broad Frequency Coverage
- Low Insertion Loss
- High Isolation
- High Power Handling

Description

The product named OH103E-2496-2690 is high-performance stripline surface mount circulator designed for telecommunications and RF applications.



Technical indicators

Size Spec	Part Nbr	Freq. (MHz)	Return Loss (dB)	Isolation (dB)	Insertion Loss (dB)	IMD3 (dBc)	Power (W)	Operating Temp (°C)
10mm	OH103E	2496-2690	20	20	0.30	-60 2*5W	70	-40 ~ 105

Mechanical Outline

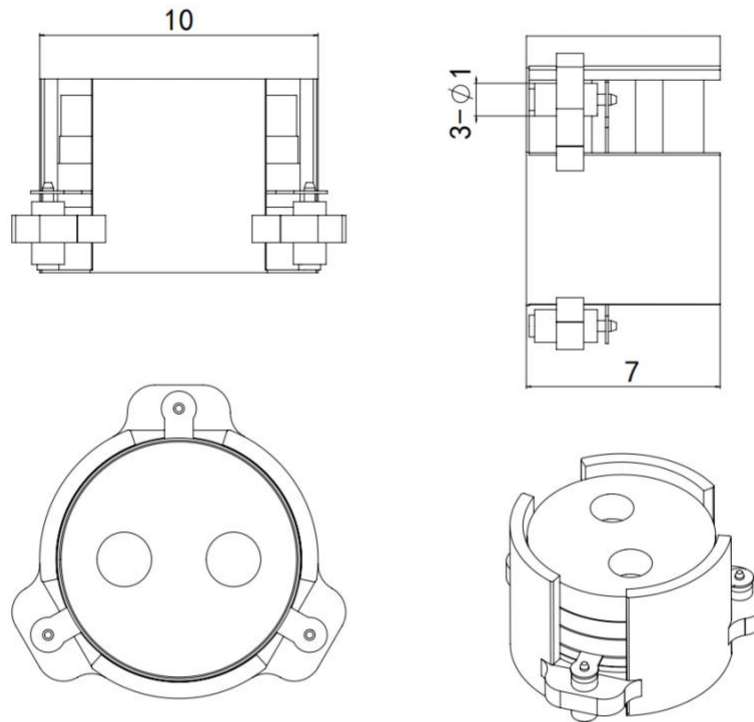



Performance Data

