



OH103E-3400-3600



Features

- Surface Mount Package
- Broad Frequency Coverage
- Low Insertion Loss
- High Isolation
- High Power Handling

Description

The product named OH103E-3400-3600 is high-performance stripline surface mount circulator designed for telecommunications and RF applications.



Technical indicators

Size Spec	Part Nbr	Freq. (MHz)	Return Loss (dB)	Isolation (dB)	Insertion Loss (dB)	IMD3 (dBc)	Power (W)	Operating Temp (°C)
10mm	OH103E	3400-3600	20	22	0.25	-60 2*5W	70	-40 ~ 105

Mechanical Outline

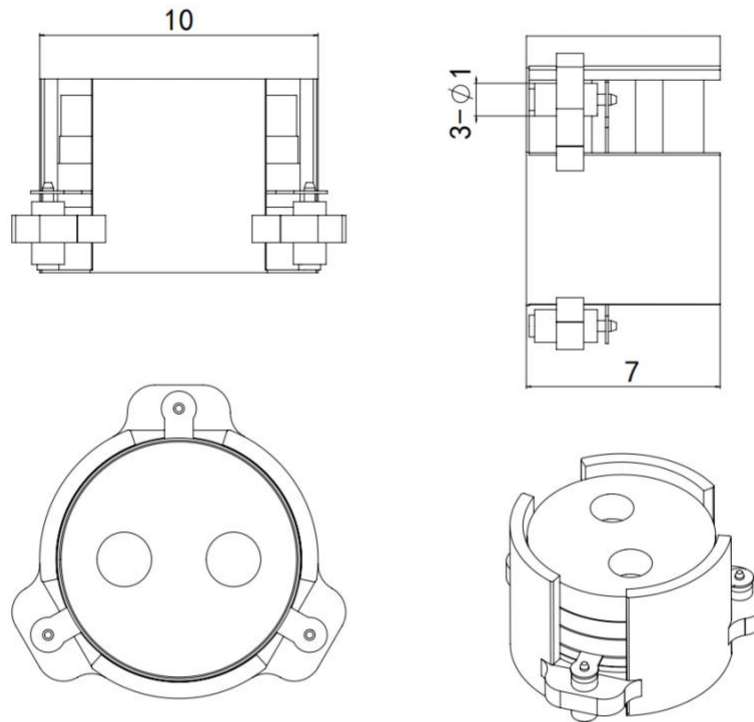



Performance Data

