



# OH103E-4800-5000



## Features

- Surface Mount Package
- Broad Frequency Coverage
- Low Insertion Loss
- High Isolation
- High Power Handling

## Description

The product named OH103E-4800-5000 is high-performance stripline surface mount circulator designed for telecommunications and RF applications.



### Technical indicators

Size Spec	Part Nbr	Freq. (MHz)	Return Loss (dB)	Isolation (dB)	Insertion Loss (dB)	IMD3 (dBc)	Power (W)	Operating Temp (°C)
10mm	OH103E	4800-5000	22	22	0.25	-60 2*5W	70	-40 ~ 105

### Mechanical Outline

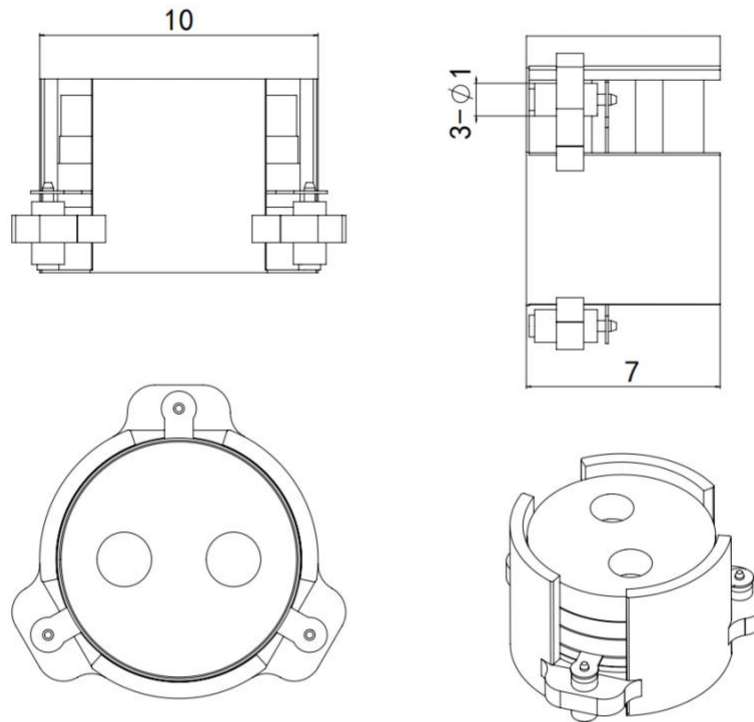



## Performance Data

