



OH120A-3300-3600



Features

- Stripline design
- Surface mount package
- Wide frequency coverage
- Low insertion loss
- High isolation
- Excellent IMD3 performance

Description

The product named OH120A-3300-3600 is high-performance stripline surface mount circulator designed for telecommunication applications requiring a compact form factor and excellent electrical performance.



Technical Indicators

Size Spec	Part Number	Freq. (MHz)	Return Loss (dB)	Isolation (dB)	Insertion Loss (dB)	IMD3 (dBc)	Power (W)	Operating Temp (°C)
12.7*12.7mm	OH120A	3300-3600	20	20	0.25	-65 (2*10W)	100	-40 ~ 125

Environmental Parameters

Operating Temp (°C)
-40 ~ 125

Mechanical Outline

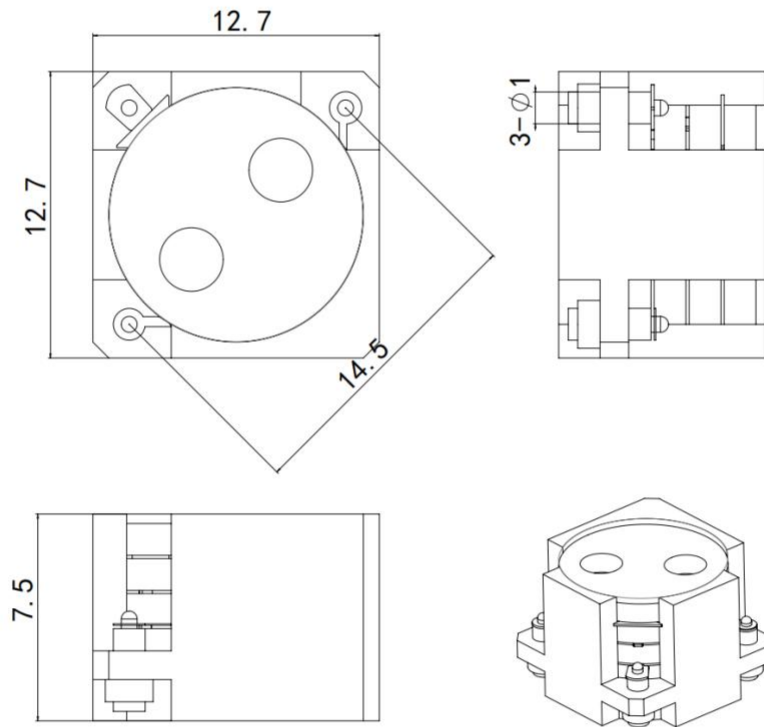



Performance Data

