



OH121A-2496-2690



Features

- Stripline technology
- Surface mount package
- Wide frequency range coverage
- High isolation
- Low insertion loss
- High power handling up to 50W
- Wide operating temperature range (-40°C to +125°C)

Description

The product named OH121A-2496-2690 is high-performance surface mount circulator designed for stripline applications, offering excellent isolation and low insertion loss across its operating frequency range.



Technical indicators

Size Spec	Part Nbr	Freq. (MHz)	Return Loss (dB)	Isolation (dB)	Insertion Loss (dB)	IMD3 (dBc)	Power (W)	Operating Temp (°C)
9*9mm	OH121A	2496-2690	20	20	0.35	-60 (2*5W)	50	-40 ~ 125

Mechanical Outline

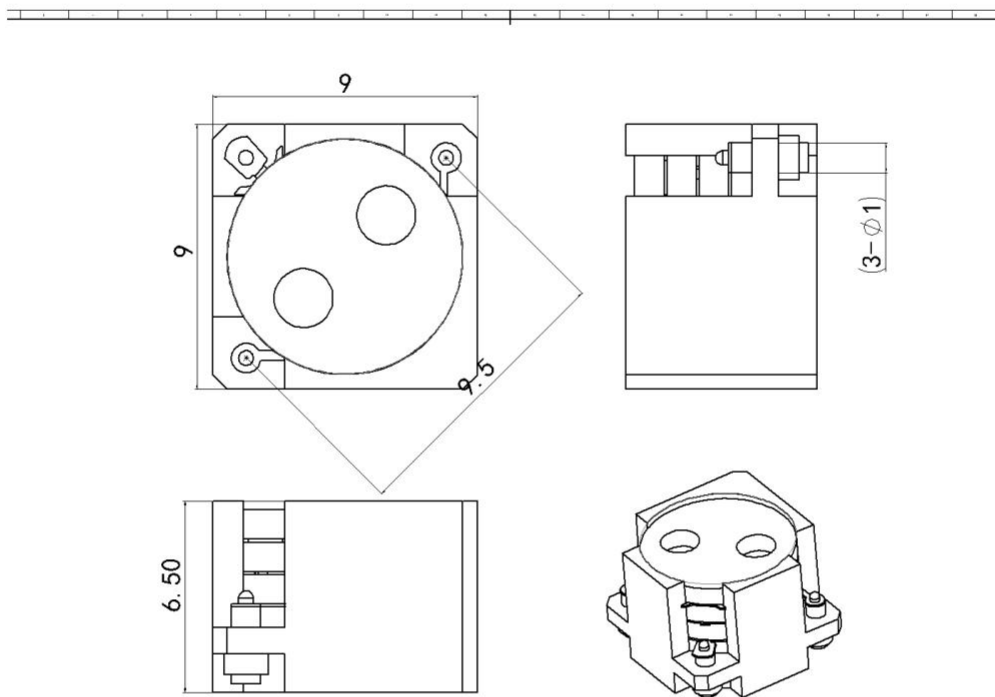



Performance Data

