

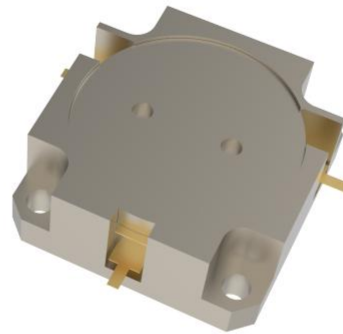

OH532-2300-2400



Features

- Embedded stripline design
- High isolation up to 23dB
- Low insertion loss as low as 0.25dB
- High power handling capacity
- Wide operating temperature range from -40 to +85 °C
- Excellent IMD3 performance

Description

The product named OH532 is high-performance embedded circulator designed for stripline applications, offering excellent isolation and low insertion loss across its operating frequency range.



Technical indicators

Size Spec	Freq. (MHz)	Return Loss (dB)	Isolation (dB)	Insertion Loss (dB)	IMD3 (dBc)	Power (W)	Operating Temp (°C)
1.0inch	2300-2400	23	23	0.25Summertime/2005-01-01 00:00:00.000000000Z	-65	2*50W 250	-40 ~ 85

Mechanical Outline

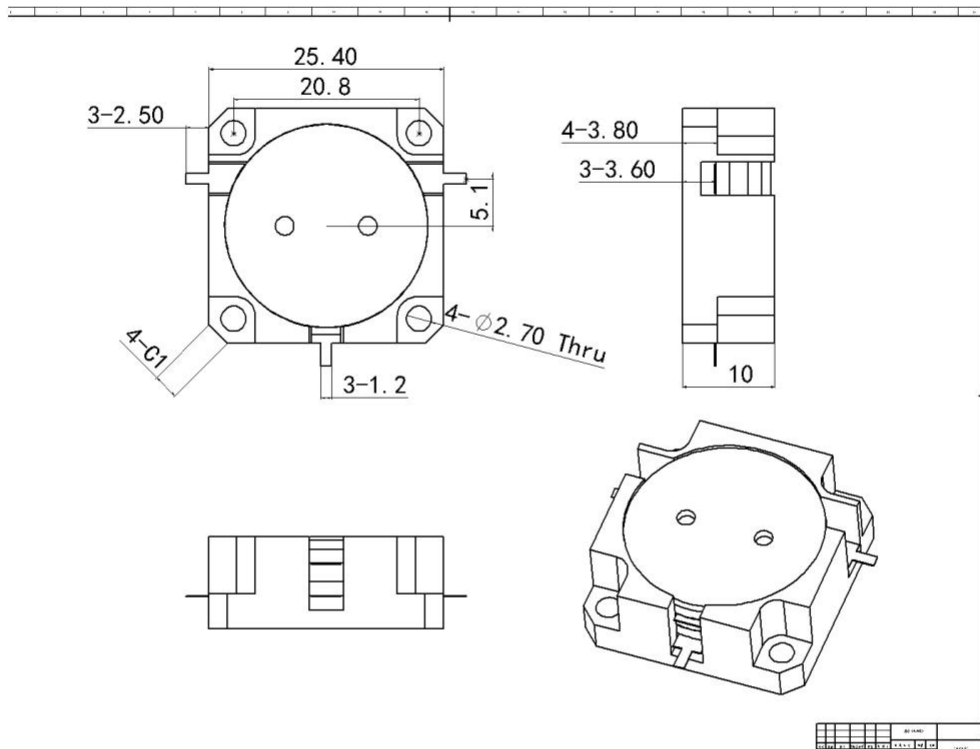



Performance Data

