

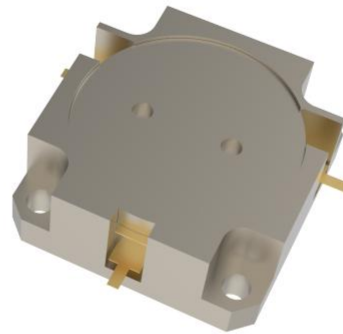

# OH532-925-960



## Features

- Embedded stripline design
- High isolation up to 23dB
- Low insertion loss as low as 0.25dB
- High power handling capacity
- Wide operating temperature range from -40 to +85 °C
- Excellent IMD3 performance

## Description

The product named OH532 is high-performance embedded circulator designed for stripline applications, offering excellent isolation and low insertion loss across its operating frequency range.



### Technical indicators

Size Spec	Freq. (MHz)	Return Loss (dB)	Isolation (dB)	Insertion Loss (dB)	IMD3 (dBc)	Power (W)	Operating Temp (°C)
1.0inch	925-960	22	22	0.25Summertime/2005-01-01 00:00:00.000000000Z	-65	2*50W 250	-40 ~ 85

### Mechanical Outline

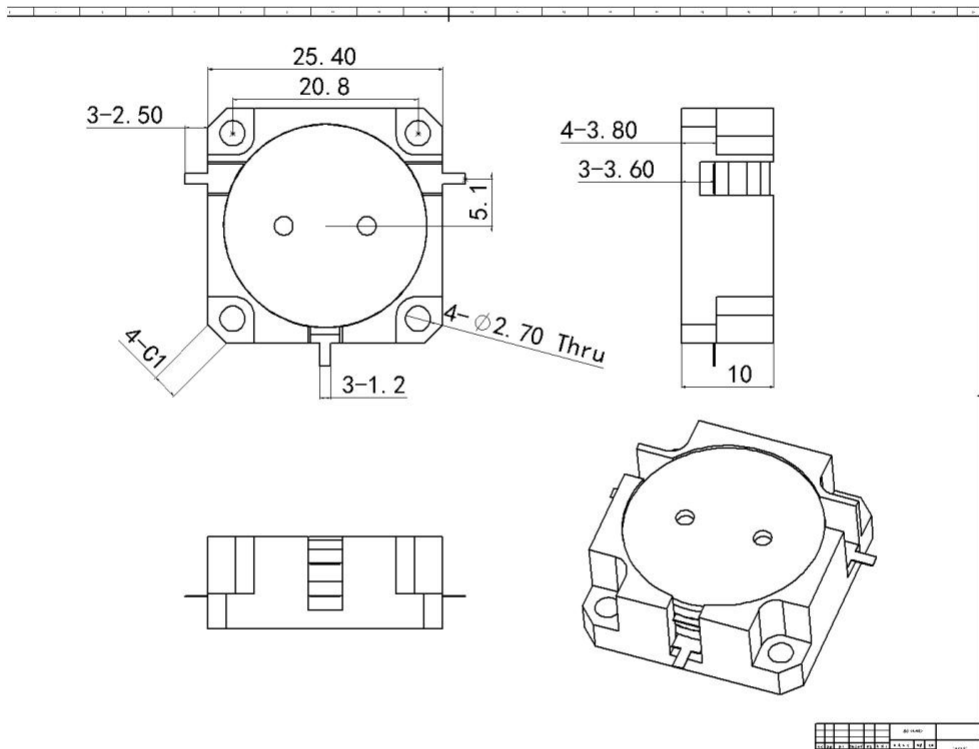



## Performance Data

