

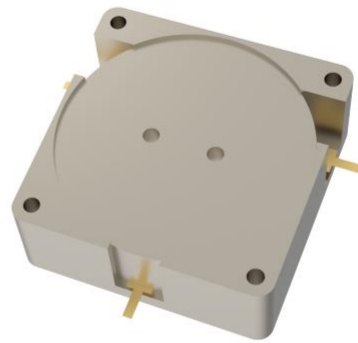

OH542-566-678



Features

- Stripline Embedded Circulator
- High Isolation
- Low Insertion Loss
- Stable Performance over Temperature
- High Power Handling Capability

Description

The product named OH542-566-678 is a high-performance stripline embedded circulator designed for telecommunications applications, offering excellent isolation and low insertion loss across its operating frequency range.



Technical indicators

Size Spec	Part Number	Freq. (MHz)	Return Loss (dB)	Isolation (dB)	Insertion Loss (dB)	IMD3 (dBc)	Power (W)	Operating Temp (°C)
1.25inch	OH542	566-678	20	20	0.40	-65 (2*50W)	300	-40 ~ 105

Mechanical Outline

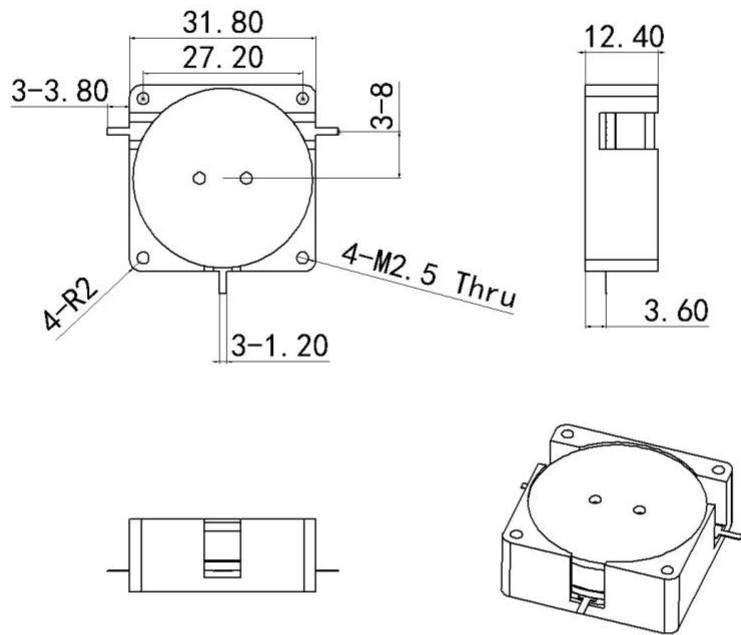



Performance Data

