

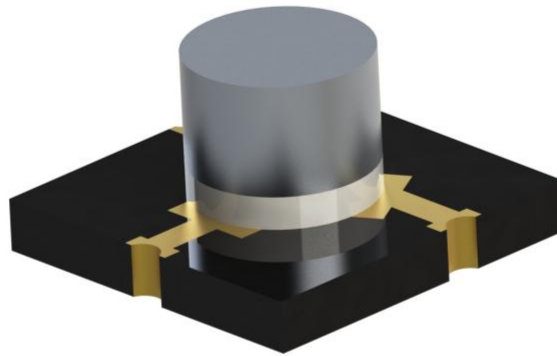

OH5A019-13000-15000



Features

- Small size
- Light weight
- High consistency
- High reliability
- Customizable
- Suitable for aviation and aerospace
- Suitable for radar and electronic countermeasures
- Suitable for microwave communications
- Suitable for microwave testing

Description

The product named OH5A019 is high-performance, small size, light weight, and features high consistency and reliability. This circulator for microstrip patch antenna is customizable and suitable for aviation, aerospace, radar, electronic countermeasures, microwave communications, and microwave testing fields. It serves functions such as impedance matching, decoupling, unidirectional transmission, and signal processing in integrated circuits.



Technical indicators

Size Spec	Freq. (MHz)	Insertion Loss (dB)	Isolation (dB)	Return Loss (dB)	Power (W)	Operating Temp (°C)
5.0x5.0x3.0	13000-15000	0.5	18.0	1.30	15.0	-55~+85

Mechanical Outline

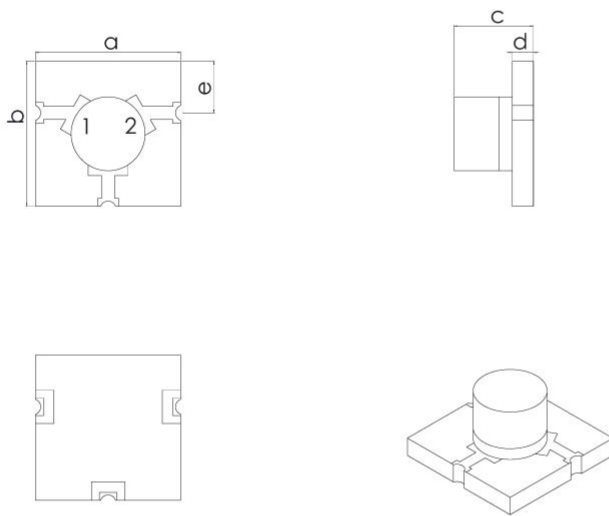



Performance Data

