

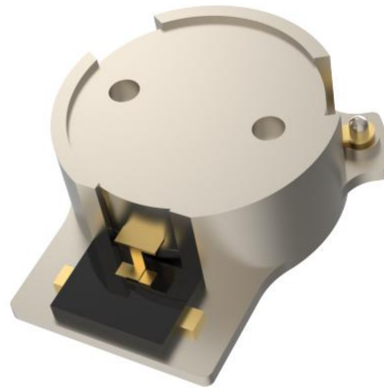

OHYG101B-758-803



Features

- Low Insertion Loss
- High Isolation
- High Power Handling
- Compact Surface Mount Package
- Wide Operating Temperature Range

Description

The product named OHYG101B is high-performance stripline surface-mounted isolator designed for robust operation in telecommunication systems. It features excellent isolation, low insertion loss, and high power handling capabilities over various frequency bands.



Technical indicators

Size Spec	Freq. (MHz)	Return Loss (dB)	Isolation (dB)	Insertion Loss (dB)	IMD3 (dBc)	Forward Power (W)	Reverse Power (W)	Operating Temp (°C)
23.4mm	758-803	22	22	0.25	-70 (2*50W)	200	100	-40 ~ 120

Mechanical Outline

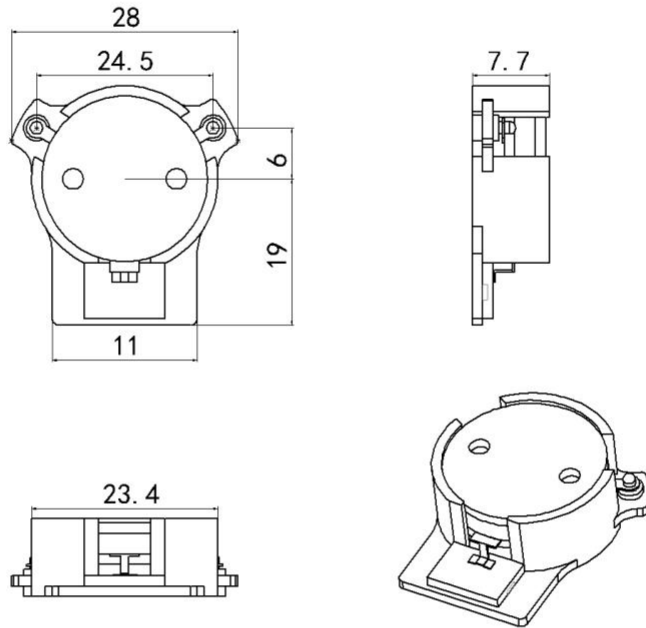



Performance Data

