

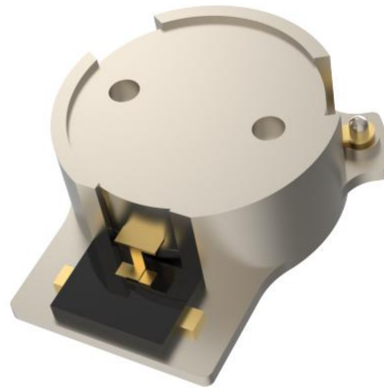

# OHYG101B-859-894



## Features

- Low Insertion Loss
- High Isolation
- High Power Handling
- Compact Surface Mount Package
- Wide Operating Temperature Range

## Description

The product named OHYG101B is high-performance stripline surface-mounted isolator designed for robust operation in telecommunication systems. It features excellent isolation, low insertion loss, and high power handling capabilities over various frequency bands.



### Technical indicators

Size Spec	Freq. (MHz)	Return Loss (dB)	Isolation (dB)	Insertion Loss (dB)	IMD3 (dBc)	Forward Power (W)	Reverse Power (W)	Operating Temp (°C)
23.4mm	859-894	22	22	0.25	-70 (2*50W)	200	100	-40 ~ 120

### Mechanical Outline

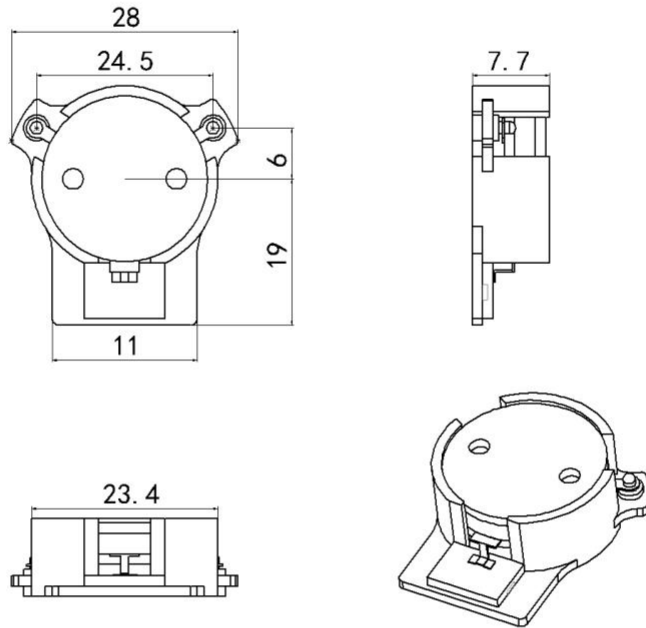



## Performance Data

