

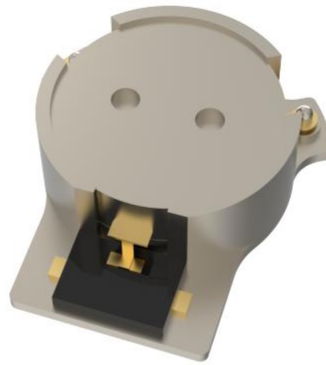

# OHYG111B-758-821



## Features

- Surface-mounted design
- Stripline structure
- Low insertion loss
- High isolation
- High power handling capacity
- Wide operating temperature range

## Description

The product named OHYG111B-758-821 is high-performance stripline surface-mounted isolator designed for robust signal conditioning and power management in wireless communication systems.



### Technical indicators

Size Spec	Freq. (MHz)	Return Loss (dB)	Isolation (dB)	Insertion Loss (dB)	IMD3 (dBc)	Forward Power (W)	Reverse Power (W)	Operating Temp (°C)
31mm	758-821	21	21	0.25	-68 @ 2*50W	200	100	-40 to 120

### Environmental Parameters

Feature	Value
Operating Temp	-40 to 120 degrees Celsius

### Absolute Max Ratings

Forward Power (W)	Reverse Power (W)	Operating Temp (°C)
200	100	-40 to 120

### Mechanical Outline

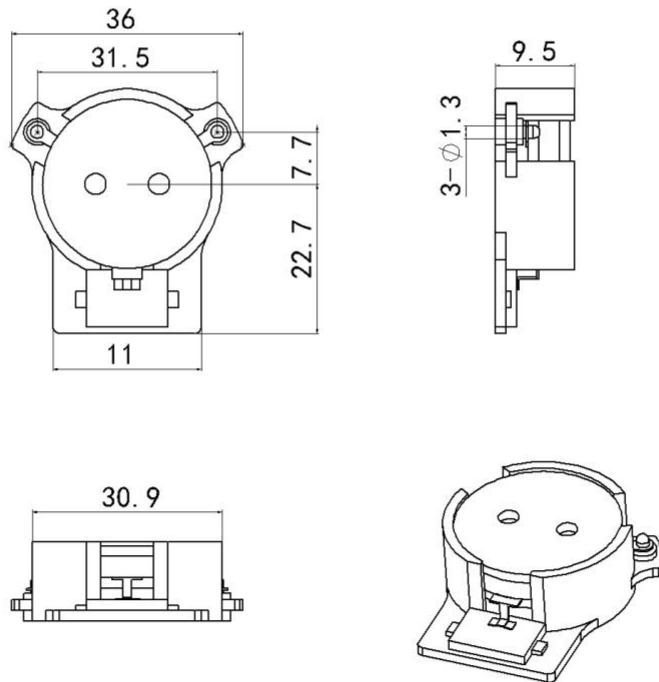



## Performance Data

