

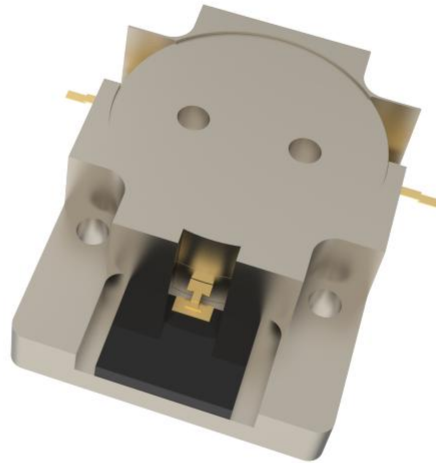

OHYG50 5M-758-803



Features

- Embedded Stripline Isolator
- Low Insertion Loss
- High Isolation
- Wide Operating Temperature Range
- High Forward/Reverse Power Handling

Description

The product named OHYG50 5M 758-803 is high-performance embedded isolator designed for stripline applications, offering excellent isolation and low insertion loss across the 758-803 MHz frequency range.



Technical indicators

Size Spec	Part Number	Freq. (MHz)	Return Loss (dB)	Isolation (dB)	Insertion Loss (dB)	IMD3 (dBc)	Test Power	Forward Power (W)	Reverse Power (W)	Operating Temp (°C)
1.0inch	OHYG 505M	758-803	22	22	0.25	-68	2*50W	200	100	-40 ~ 120

Mechanical Outline

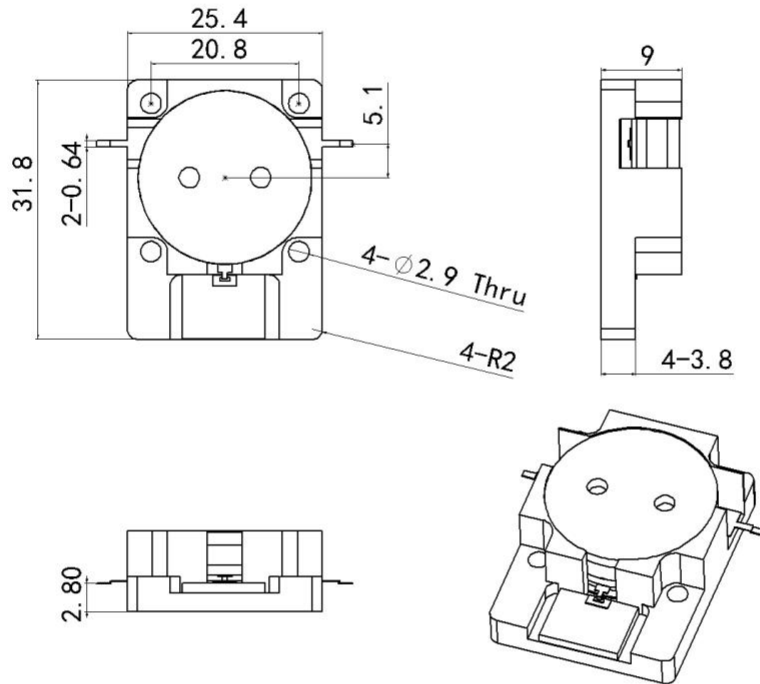

⊞



Performance Data

