

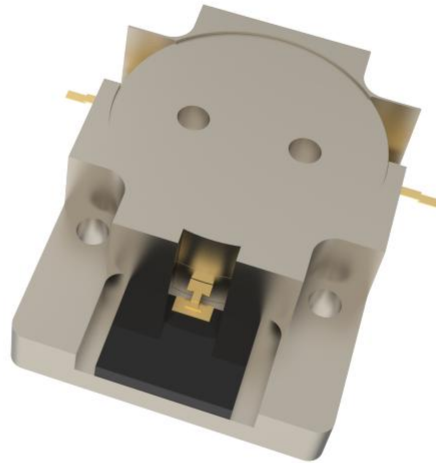

# OHYG50 5M-791-821



## Features

- Embedded Stripline Isolator
- Low Insertion Loss
- High Isolation
- Wide Operating Temperature Range
- High Forward/Reverse Power Handling

## Description

The product named OHYG50 5M 791-821 is high-performance embedded isolator designed for stripline applications, offering excellent isolation and low insertion loss across the 791-821 MHz frequency range.



### Technical indicators

Size Spec	Part Number	Freq. (MHz)	Return Loss (dB)	Isolation (dB)	Insertion Loss (dB)	IMD3 (dBc)	Test Power	Forward Power (W)	Reverse Power (W)	Operating Temp (°C)
1.0inch	OHYG 505M	791-821	22	22	0.25	-68	2*50W	200	100	-40 ~ 120

### Mechanical Outline

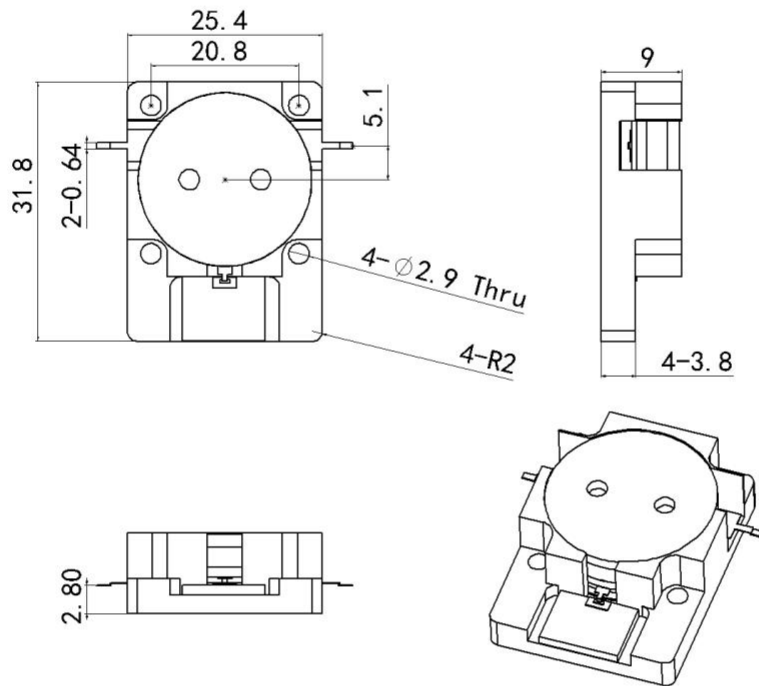

⊞



## Performance Data

