

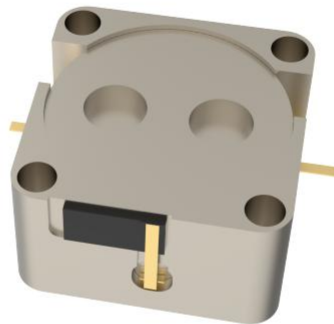

# OHYG563D-2110-2170



## Features

- Embedded Isolator
- Stripline product
- High isolation
- Low insertion loss
- Wide temperature range

## Description

The product named OHYG563D-2110-2170 is high-performance stripline embedded isolator designed for reliable signal isolation in communication systems.



### Technical indicators

Size Spec	Part Number	Freq. (MHz)	Return Loss (dB)	Isolation (dB)	Insertion Loss (dB)	IMD3 (dBc)	Forward Power (W)	Reverse Power (W)	Operating Temp (°C)
0.5inch	OHYG563E	2110-2170	20	20	0.30	-62 2*10W	80	10	-40 ~ 85

### Mechanical Outline

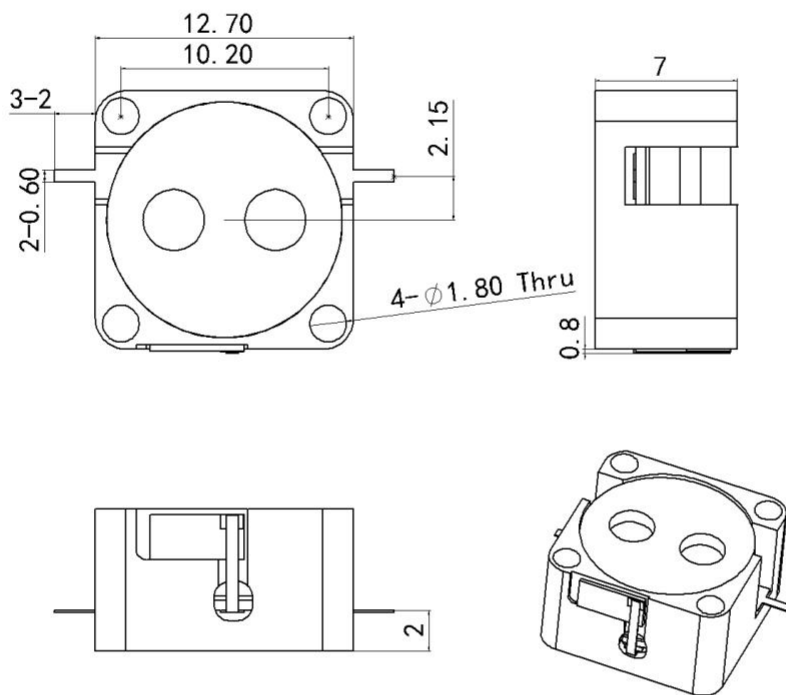



## Performance Data

