

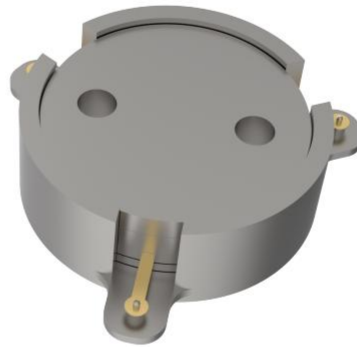

# OHYH101B-2496-2690



## Features

- Stripline design
- Surface mount package
- High isolation
- Low insertion loss
- Wide operating temperature range

## Description

The product named OHYH101B-2496-2690 is high-performance stripline surface mount circulator designed for robust signal routing in RF communication systems, offering excellent performance across a range of technical indicators.



### Technical indicators

Size Spec	Part Number	Freq. (MHz)	Return Loss (dB)	Isolation (dB)	Insertion Loss (dB)	IMD3 (dBc)	Power (W)	Operating Temp (°C)
23.4mm	OHYH101B	2496-2690	22	22	0.30	-60	2 50W / 250	-40 ~ 120

### Mechanical Outline

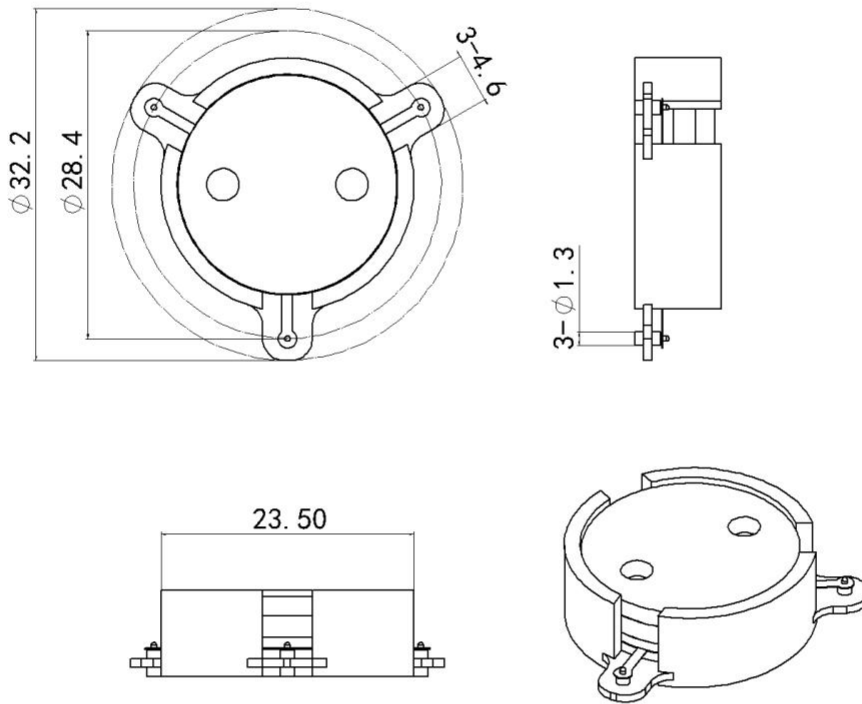



## Performance Data

