

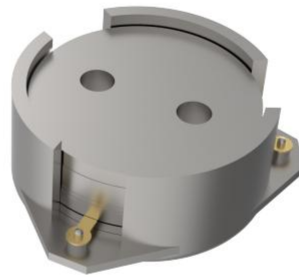

OHYH103B-2110-2170



Features

- Surface mount package
- Low insertion loss
- High isolation
- High power handling up to 120W
- Stable performance across temperature range

Description

The product named OHYH103B-2110-2170 is high-performance stripline surface mount circulator designed for telecommunications applications.



Technical Indicators

Size Spec	Part Nbr	Freq. (MHz)	Return Loss (dB)	Isolation (dB)	Insertion Loss (dB)	IMD3 (dBc)	Power (W)	Operating Temp (°C)
15.5mm	OHYH103E	2110-2170	21	21	0.30	-65	2*20W / 120	-40 ~ 105

Mechanical Outline

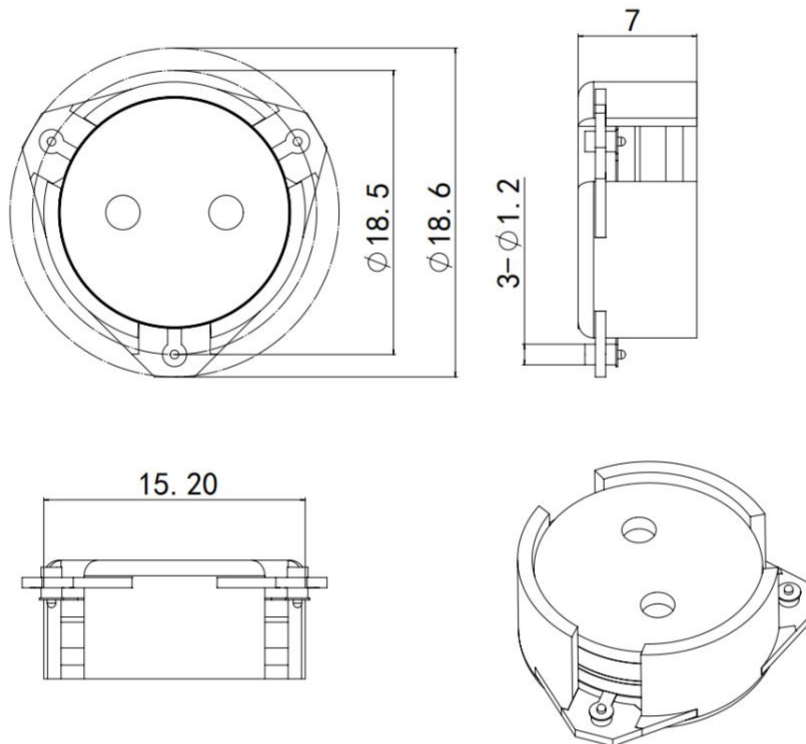



Performance Data

