

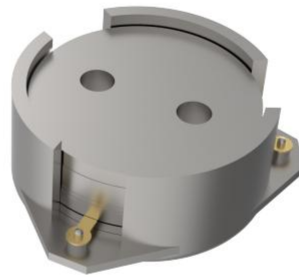

OHYH103B-3400-3600



Features

- Surface mount package
- Low insertion loss
- High isolation
- High power handling up to 120W
- Stable performance across temperature range

Description

The product named OHYH103B-3400-3600 is high-performance stripline surface mount circulator designed for telecommunications applications.



Technical Indicators

Size Spec	Part Nbr	Freq. (MHz)	Return Loss (dB)	Isolation (dB)	Insertion Loss (dB)	IMD3 (dBc)	Power (W)	Operating Temp (°C)
15.5mm	OHYH103E	3400-3600	22	22	0.30	-65	2*20W / 120	-40 ~ 125

Mechanical Outline

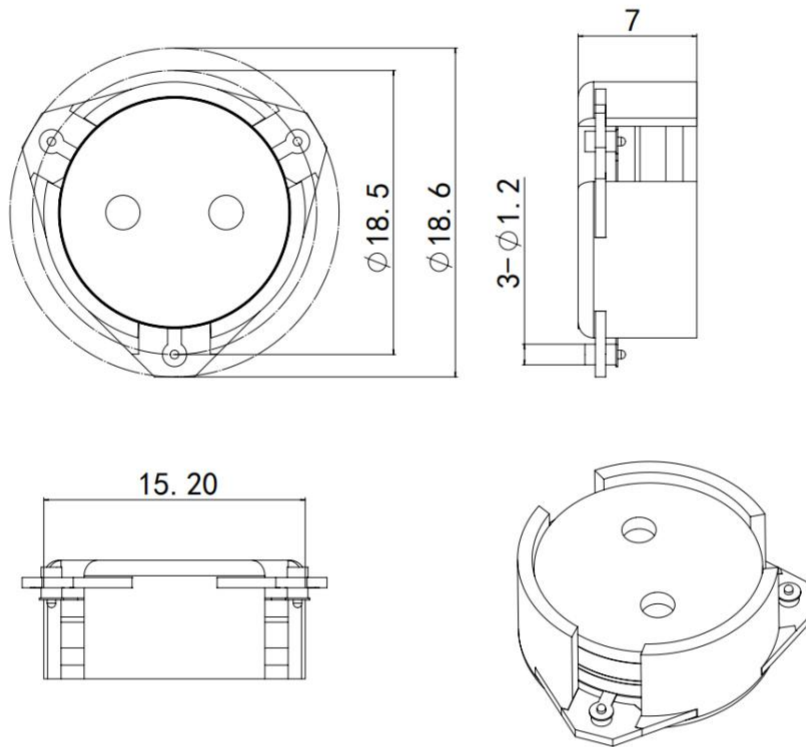



Performance Data

