

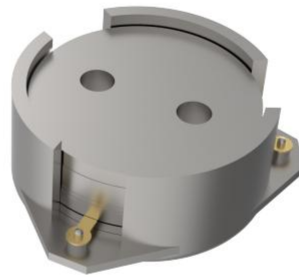

# OHYH103B-930-960



## Features

- Surface mount package
- Low insertion loss
- High isolation
- High power handling up to 120W
- Stable performance across temperature range

## Description

The product named OHYH103B-930-960 is high-performance stripline surface mount circulator designed for telecommunications applications.



## Technical Indicators

Size Spec	Part Nbr	Freq. (MHz)	Return Loss (dB)	Isolation (dB)	Insertion Loss (dB)	IMD3 (dBc)	Power (W)	Operating Temp (°C)
15.5mm	OHYH103E	930-960	20	20	0.30	-60	2*20W / 120	-40 ~ 125

## Mechanical Outline

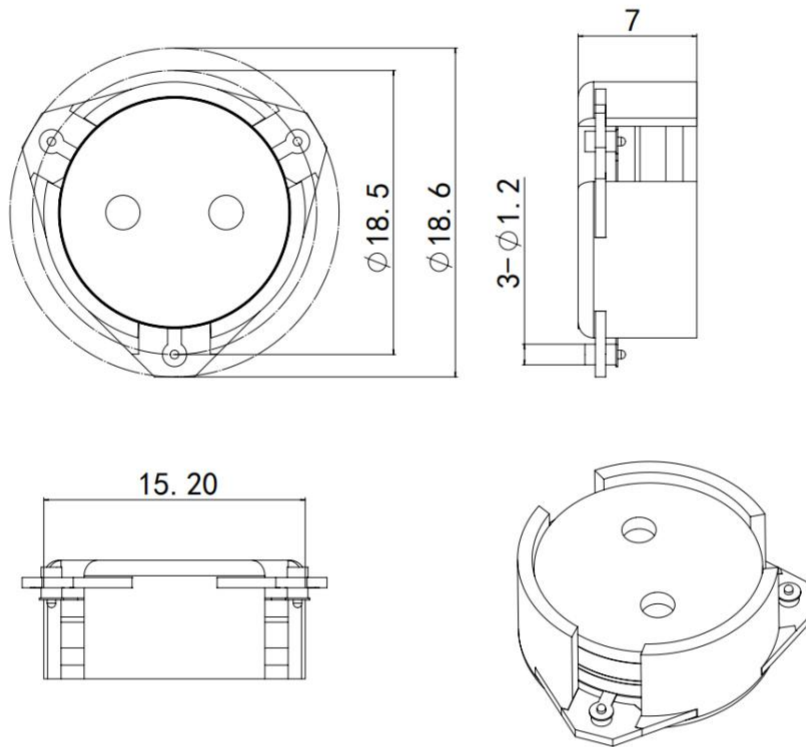



## Performance Data

