

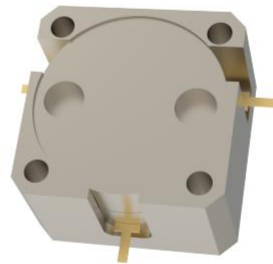

OHYH524C-2110-2170



Features

- Embedded circulator design
- High isolation of 23 dB
- Low insertion loss of 0.25 dB
- High power handling capability up to 160W
- Operating temperature range from -40 to +85 Celsius

Description

The product named OHYH524C-2110-2170 is high-performance stripline embedded circulator designed for RF signal isolation and routing in telecommunication systems.



Technical indicators

Size Spec	Part Nbr	Freq. (MHz)	Return Loss (dB)	Isolation (dB)	Insertion Loss (dB)	IMD3 (dBc)	Power (W)	Operating Temp (°C)
0.75inch	OHYH524C	2110-2170	23	23	0.25	-65 @ 2x30W	160	-40 ~ 85

Mechanical Outline

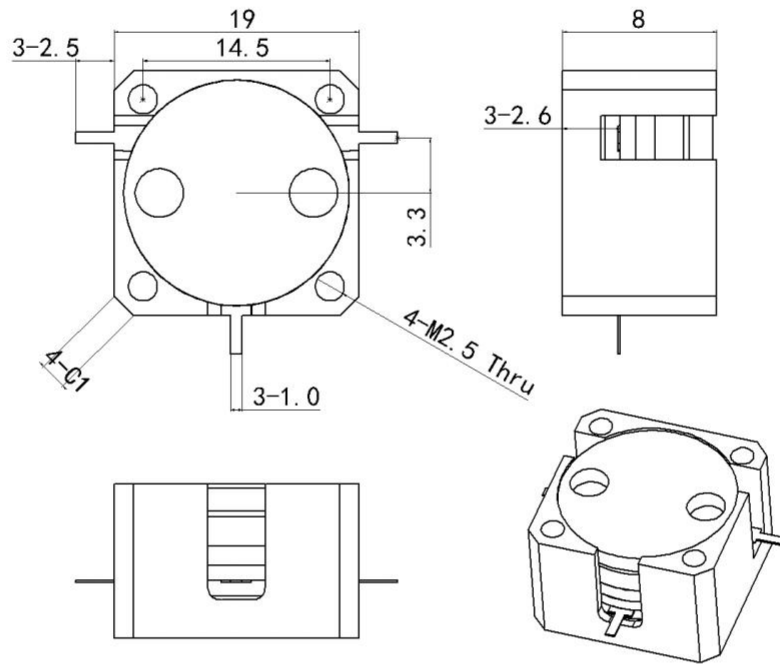



Performance Data

