

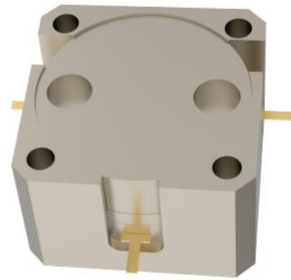

OHYH531A-2400-2500



Features

- Embedded stripline design
- High isolation up to 20dB
- Low insertion loss of 0.30dB
- Broad operating temperature range from -40 to +85°C
- High power handling capability up to 100W

Description

The product named OHYH531A-2400-2500 is high-performance Stripline Products: Embedded Circulator designed for telecommunications applications, featuring robust performance and reliable signal isolation.



Technical indicators

Size Spec	Part Number	Freq. (MHz)	Return Loss (dB)	Isolation (dB)	Insertion Loss (dB)	IMD3 (dBc)	Power (W)	Operating Temp (°C)
0.5inch	OHYH531A	2400-2500	20	20	0.30	-62 2*10W	100	-40 ~ 85

Mechanical Outline

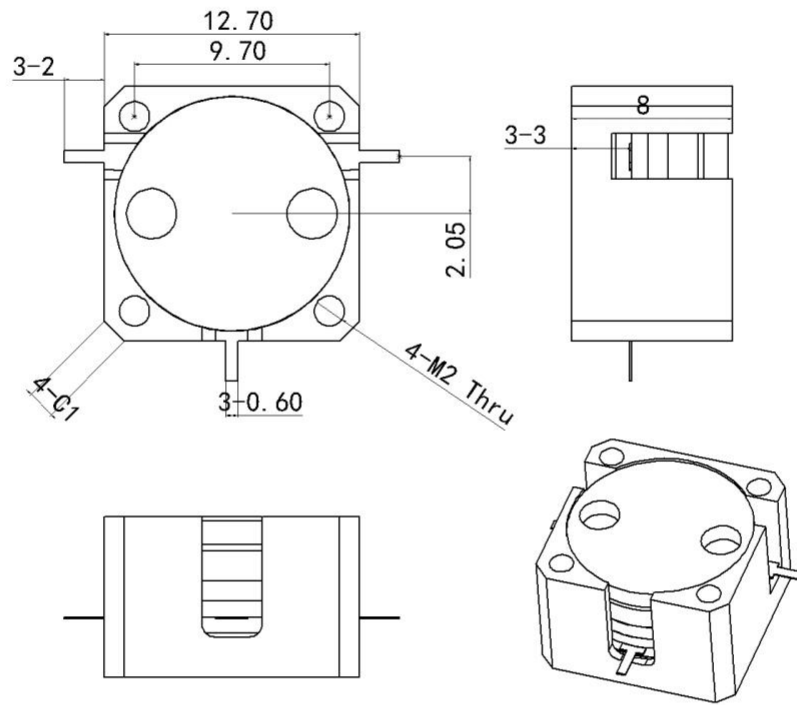



Performance Data

