



OHYH101P-610-660



Features

- Stripline configuration
- Surface mount design
- High isolation
- Low insertion loss
- Wide frequency range coverage

Description

The product named OHYH101P is high-performance stripline surface mount circulator designed for telecommunication applications, offering high isolation and low insertion loss across its operating bandwidth.



Technical indicators

Size Spec	Freq. (MHz)	Return Loss (dB)	Isolation (dB)	Insertion Loss (dB)	IMD3 (dBc)	Power (W)	Operating Temp (°C)
25.4mm	610-660	20	20	0.25	-60 (2*50W)	250	-40 ~ 105

Mechanical Outline

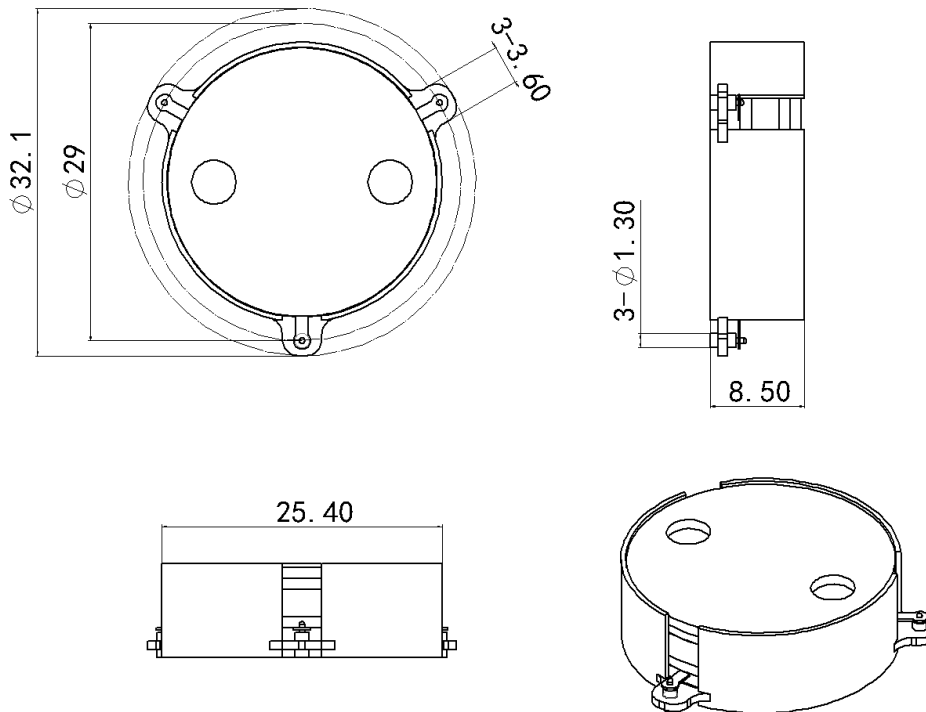



Performance Data

